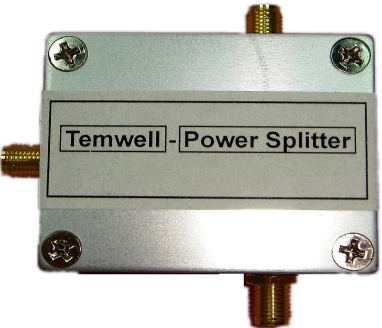
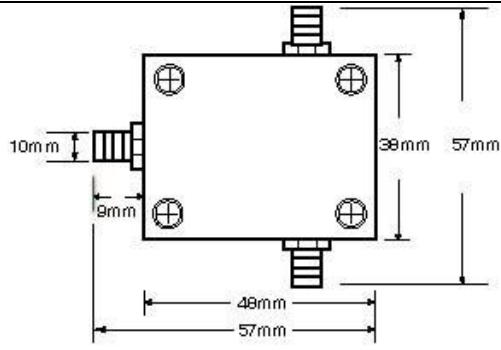

# TEMWELL Power Splitter Specification Sheet

Customer Name		Temwell's Part No.	P02S-1.4G~1.7G-SMA
Approval No. /dated	201211075CD	Temwell's Print Name	1.4G~1.7G
Work Instruction No.	201211075CD	Date	Dec.05.2012

<p>(1)Dimension</p> 	<p>(2)Size Diagram</p>  <p style="text-align: center;">L:57mm / W:57mm / H:34mm NW: 180g</p>
---	--

(3)Electric Character				
	Item	Specify	Coupling Loss	Performance
	Frequency Range (MHz)	1.4G~1.7G	-	1.4G~1.7G
	Insertion Loss S21 (dB)	Max. 1.0 dB	3	0.52 dB
	Insertion Loss S31 (dB)	Max. 1.0 dB	3	0.54 dB
	Return Loss output 1 (S11) (dB)	Min. 12 dB	-	28.8 dB
	Return Loss output 2 (S22) (dB)	Min. 12 dB	-	27.1 dB
	Return Loss output 3 (S33) (dB)	Min. 12 dB	-	24.9 dB
	Isolation S23 (dB)	Min. 20 dB	-	22.6 dB
	Phase Balance (Deg)	Max.	-	
	VSWR	Max.	-	
(4)Impedance all port		In / Out : 50 Ω	In / Out : 50 Ω	
(5)Input Power		> 30 Watt		
(6)Temperature Condition:				
Operating Temperature		-30°C ~ +70°C		
Storage Temperature		-30°C ~ +80°C		
Approval	Supervisor	Designer	Connector type	
C.Y.Chang	C.K.Chang	Chang.Peter	SMA type	
TEMWELL CORPORATION				

# TEMWELL Power Splitter Performance

